

ETOILE

FUTURISTIC DESIGN TRENDS

CRIDCABIN
TASTE PRESENTATION





Etoile represents innovation in display. A refrigerated counter with an innovative display concept: a square refrigerated display case that makes a big emotional impact. The enclosed products shine, as precious as jewels in a display case.

IT

Etoile è innovazione nell'esposizione.

Un banco refrigerato dal concept espositivo innovativo, una vetrina refrigerata squadrata dal forte impatto emozionale, che fa risplendere i prodotti racchiusi al suo interno, preziosi come gioielli in una teca.

The Ferrari of Refrigeration



ETOILE G-CONCEPT

Much more than a simple butcher's refrigerated counter. Etoile is finished to very high level and able to meet the latest trends in modern design. The flagship product in our custom-made range.

IT
Molto più che un semplice banco refrigerato per la macelleria. Etoile è un prodotto dalle finiture di altissimo livello che riesce a soddisfare le più moderne tendenze del design. La punta di diamante tra i nostri prodotti "custom made".

FR
Beaucoup plus qu'un simple comptoir réfrigéré pour les boucheries. Etoile est un produit avec des finitions de prestige en mesure de satisfaire les dernières tendances de design moderne. Le fleuron de nos produits "custom made".

DE
Viel mehr als eine einfache Kühltheke für die Metzgerei. Etoile ist ein Produkt mit hoher Verarbeitungsqualität, das den neuesten Designtrends entspricht. Das Juwel in der Krone unserer maßgefertigten Produkte.

1 G-Concept, refrigeration system by glycoled water, ideal for meat displaying.

IT G-Concept, sistema di refrigerazione con acqua glicolata ideale per l'esposizione delle carni.

FR G-Concept, système de réfrigération par eau glicolée, idéal pour l'exposition de la viande.

DE G-Konzept, Kühlsystem mit Glykolwasser für die Ausstellung des Fleisches geeignet.

2 "Extra clear" glass finishing. Upwards opening by pistons.

IT Vetro finitura "Extra chiaro" apribile verso l'alto a pistoni.

FR Glace en finition "extra claire" ouvrable vers haut par vérins.

DE "Extra Clear" Gläser mit Kippöffnung nach oben beim Stossdämpfer.



- 3** Counter dimensions – height, length, depth – upon customer request.
- IT** Dimensioni del banco – altezza, larghezza e profondità – realizzabili su richiesta del cliente.
- FR** Dimensions de la vitrine – hauteur, largeur, profondeur – réalisables sur requête du client.
- DE** Theken Masse – Höhe, Breite und Tiefe – machbar bei Anfrage des Kunden.

- 4** CRIOLED® lighting.
- IT** Illuminazione CRIOLED®.
- FR** Éclairage CRIOLED®.
- DE** CRIOLED®-Beleuchtung.

- 5** Tank without freezing components to allow maximum cleaning.
- IT** Vasca senza componenti frigoriferi per garantire la massima pulizia.
- FR** Cuve sans composantes frigorifiques afin de garantir le nettoyage maximum.
- DE** Wanne ohne Kühlbestandteile um maximale Reinigung zu garantieren.

- 6** Angled sections in any possible degrees.
- IT** Angoli realizzabili di qualsiasi gradazione.
- FR** Angles réalisables en n'importe quel degré.
- DE** Winkel von jeder Stärke.

- 7** Strong working board in antiscratch stainless steel with 1 cm reinforcement and insulated by injected polyurethane.
- IT** Robusto piano di lavoro in acciaio inox antigraffio con rinforzo da 1 cm e isolato mediante iniezione di poliuretano.
- FR** Tablette de travail robuste en acier inox antirayure avec renforcement 1 cm et isolé par injection de polyurethane.
- DE** Festes Arbeitsbrett aus kratzfestem Edelstahl mit Verstärkung von 1 cm und getrennt mit Polyurethan-Injektion.



8 Paper holder with anti-fall fixing bars.

IT Portacarta completi di barre di fissaggio che ne evitano la caduta.

FR Porte-papier complets de barres de fixation qui en évitent la chute.

DE Papiertaschen mit Befestigungsstangen um den Untergang zu verhindern.

9 Scale holder in stainless steel.

IT Portabilancia in acciaio inox.

FR Porte-balance en acier inox.

DE Waagebrett aus Edelstahl.

10 Monophase outlet Schuko 16A, Italian outlet 10A.

IT Prese monofase Schuko 16A, presa italiana 10A.

FR Prises monophasés Schuko 16A, prise italienne 10A.

DE Schuko 16A monophase Stecker, italienische Steckdose 10A.

11 Gastronorm tanks holder.

IT Porta vaschette Gastronorm.

FR Porte-bacs gastronorm.

DE Trägerstruktur für Gastgewerbewannen.

12 Electrified compact aluminium rail for easy positioning and moving of every type of outlet.

IT Binario elettrificato compatto in alluminio dove posizionare e spostare a piacimento ogni tipo di presa.

FR Rail électrifié et compacte en aluminium où positionner et déplacer au goût chaque type de prise.

DE Elektrifizierte kompakte Laufschiene aus Aluminium wo man jede Steckdose stellen und verschieben nach Belieben kann.

13 Neutral understorage in stainless steel and stainless steel leg cover.

IT Ripiani a giorno e copertura gamba in acciaio inox.

FR Réserve arrière neutre et couverture des pieds en acier inox.

DE Ungekühlter Abstellraum und Verdeckung des Beins aus Edelstahl.

14 Knives holder.

IT Porta coltelli.

FR Porte-couteaux.

DE Messerhalter.

15 H-Combi version infrared heating ceiling lamp.

IT Plafoniera riscaldante infrarosso versione H-Combi.

FR Plafonnier chauffant infrarouge version H-Combi.

DE H-Combi Version, Deckenleuchte mit Infrarotheizung.



16 Anti-fogging front and side ventilation.

IT Ventilazione frontale antiappannante.

FR Ventilation frontale antibuée.

DE Antibeschlag
Frontumluftkühlung.

17 Perimetrical bumper skirting.

IT Zoccolo parapolvere su tutto il perimetro del banco.

FR Plinthe de sol perimetral.

DE Umlaufende Wischleiste.

Croix 



18 Front supports in chromed stainless steel.

IT Montanti anteriori in acciaio inox cromato.

FR Supports antérieurs en acier inox chromé.

DE Vordere Stützstücke aus verchromtem Edelstahl.

19 Opened 36 cm "Extra chiaro" glass top surface.

IT Piano d'appoggio in vetro "Extra chiaro" da 36 cm apribile.

FR Plan d'appui supérieur relievable en verre "Extra chiaro" de 36 cm.

DE Hochklappbare Zähltafel aus Glas "Extra chiaro", Breite: 36 cm.

20 Stainless steel unit interior.

IT Interno del mobile in acciaio Inox.

FR Intérieur de la vitrine en acier inox.

DE Innenverarbeitung des Möbels aus rostfreiem Edelstahl.

P61
White Perla 

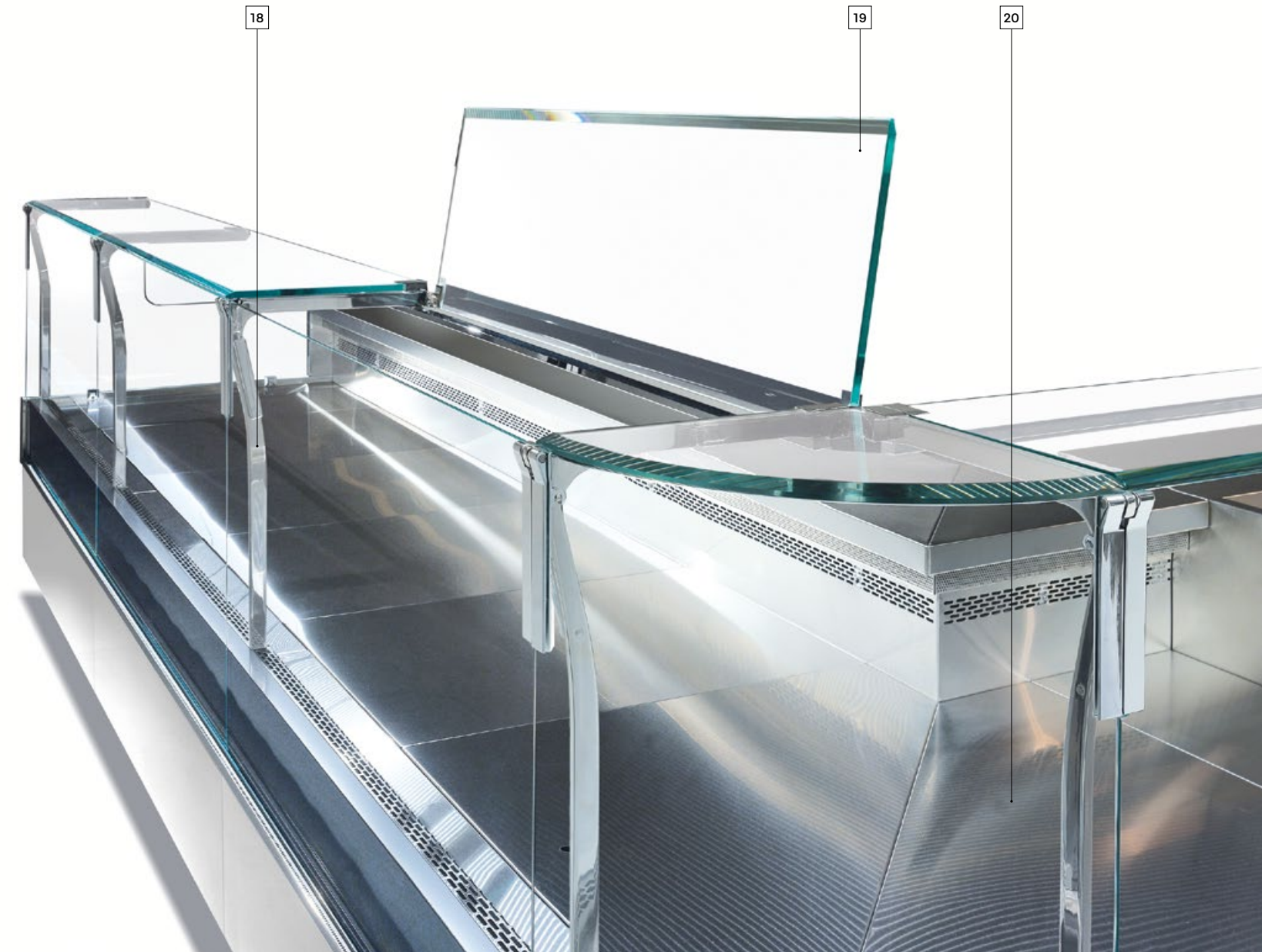

21 EDB - Refrigerated glazed display with thermopane glasses, ideal for meat maturation process "Dry Aged Beef".

IT EDB - Teca refrigerata a vetri thermopane ideale per il processo di maturazione della carne chiamato "Dry beef aged".

FR EDB - Structure vitrée avec glaces thermopane idéale pour le procès de maturation de la viande nommé "Dry Aged Beef".

DE EDB - Glasvitrine mit Thermopanglas ideal für den Reifeprozess des Fleisches "Dry beef aged" genannt.

21

22 H-Combi, heating system (air forced heat).

IT H-Combi, il sistema di riscaldamento "caldo ventilato".

FR H-Combi, système de chauffage (aire chaude ventilée).

DE H-Combi, das "Umluftkühlung warm" Heizsystem.

22

23 Evaporator handled with cataphoresis.

IT Evaporatore trattato in cataforesi.

FR Évaporateur traité à la cataphorèse.

DE Verdampfer mit Kataforese.

24 Inclined end in any possible degrees.

IT Spalla realizzabile inclinata di qualsiasi gradazione.

FR Joue inclinée en n'importe quel degré.

DE Von jeder Stärke neigbare Seitenteil.

23

24



IL MAGNIFICO TOWER



A promotional area, a display case, and the perfect showcase for ready-to-cook dishes: unique products that are the result of each butcher's experience and creativity.

The combination of glass and lighting creates display; front panes that open book-style and sliding rear panes make it easy to set up a display and enable thorough cleaning..

IT

Un'area promozionale, una teca, la vetrina perfetta per i preparati pronti a cuocere, prodotti unici frutto dell'esperienza e della creatività di ciascun macellaio. La combinazione di vetrate e illuminazione crea l'esposizione ottimale, i vetri anteriori apribili "a libro" e i vetri posteriori scorrevoli facilitano l'allestimento dell'esposizione oltre che ottimizzare le operazioni di pulizia.

FR

Une zone promotionnelle, un écrin, la vitrine parfaite pour les plats préparés prêts à cuire, des produits uniques, fruits de l'expérience et de la créativité de chaque boucher. La combinaison de vitrines et d'éclairage crée l'exposition parfaite, les vitres avant ouvrables à 180° et les vitres arrières coulissantes facilitent l'aménagement de l'exposition et optimisent les opérations de nettoyage.

DE

Eine Werbefläche, eine Vitrine, das perfekte Schaufenster für kochfertige Produkte, einzigartige Spezialitäten, die aus der Erfahrung und der Kreativität eines jeden Metzgers hervorgehen. Die Kombination aus Glas und Beleuchtung sorgt für eine optimale Präsentation, die vorderen „aufklappbaren“ Glasscheiben und die hinteren, verschiebbaren Glasscheiben erleichtern das Einrichten der Auslage und optimieren die Reinigungsvorgänge.





25 Display surface and 3 shelves in climate class 3-M1, ideal for displaying meat.

IT Piano esposizione e 3 ripiani in classe climatica 3-M1, ideale per l'esposizione della carne.

FR Plateau d'exposition et 3 étagères en classe climatique 3-M1, idéal pour l'exposition de la viande.

DE Ausstellungsregal und 3 Ablagen in Klimaklasse 3-M1, ideal für die Fleischauslage.

26 Thermopane silkscreened glass, "Il Magnifico Tower" version.

IT Vetri Thermopane serigrafati versione "Il Magnifico Tower".

FR Vitrites en Thermopane sérigraphiées version "Il Magnifico Tower".

DE Siebgedrucktes Thermopenglas in der Version „Il Magnifico Tower“.



WOW Touch Control.

The WOW Touch Control electronic control panel, connected to the network via an app, is the perfect interface for monitoring Etoile's performance remotely.

IT

Il quadro elettronico comandi WOW Touch Control è l'interfaccia perfetta per il monitoraggio a distanza delle rilevazioni di performance di Etoile, connesso in rete tramite app.

FR

Le tableau électronique de commandes WOW Touch Control est l'interface parfaite pour le contrôle à distance des relevés de performance d'Etoile, connecté en réseau au moyen d'une app.

DE

Das elektronische Bedienfeld WOW Touch Control ist die perfekte Schnittstelle für die Fernüberwachung der Leistungsdaten von Etoile, der über eine App vernetzt ist.



P53
Rose Brown



Doesn't It Look Like
a Jewelry Counter?

This is Etoile
video



ETOILE	L (cm)*	93,7	125	187,5	250	312,5	375	437,5	500
Consumo annuo / Annual Energy Consumption remote version	Wh	315	354	556	634	836	915	1116	1194
Potenza frigorifera / Refrigeration power Ø 24 -deft* (Tevap -10°C):	W	400	520	620	770	900	1035	1170	1320
Classe climatica / Climate Class	ISO 23953-2	3 - M1							
Superficie espositiva / Display surface	m²	0,84	1,13	1,69	2,25	2,81	3,38	3,94	4,50
Carico uniformemente distribuito piano esposizione Uniformly distributed load dispaly surface:	Kg/m²	105							
Controllo / Control:	ELECTRONIC	WOW Touch Control							

ETOILE S-CONCEPT	L (cm)*	93,7	125	187,5	250	312,5	375	437,5	500
Consumo annuo / Annual Energy Consumption remote version	kWh/a	193	232	311	389	468	548	626	704
Potenza frigorifera / Refrigeration power Ø 24 -deft* (Tevap -10°C):	W	380	500	611	710	880	1020	1150	1300
Classe climatica / Climate Class	ISO 23953-2	3 - M2							
Superficie espositiva / Display surface	m²	0,76	1,01	1,52	2,03	2,53	3,04	3,54	4,05
Carico uniformemente distribuito piano esposizione Uniformly distributed load dispaly surface:	Kg/m²	105							
Controllo / Control:	ELECTRONIC	WOW Touch Control							

ETOILE G-CONCEPT	L (cm)*	93,7	125	187,5	250	312,5	375	437,5	500
Consumo annuo / Annual Energy Consumption remote version	kWh/a	1016	1055	1257	1335	1537	1616	1817	1895
Potenza frigorifera / Refrigeration power Ø 24 -deft* (Tevap -10°C):	W	444	578	689	855	1000	1150	1300	1467
Classe climatica / Climate Class	ISO 23953-2	3 - M1							
Superficie espositiva / Display surface	m²	0,76	1,01	1,52	2,03	2,53	3,04	3,54	4,05
Carico uniformemente distribuito piano esposizione Uniformly distributed load dispaly surface:	Kg/m²	105							
Controllo / Control:	ELECTRONIC	WOW Touch Control							

ETOILE H - COMBI	L (cm)*	62,5	93,7	125	156,2	187,5
Consumo annuo / Annual Energy Consumption:	kWh/a	8239	9051	14375	15187	22133
Plafoniera riscaldante infrarossi / Heating lamp on top part	W	800	1100	1600	1900	2200
Resistenza riscaldamento ventilato / Ventilated electrical heater	W	1500	1500	3000	3000	4500
Resistenza per umidità controllata Electrical heater for controlled humidity	W	800	800	800	800	1600
Controllo / Control:	ELECTRONIC	Easy Touch Control				

IL MAGNIFICO TOWER	L (cm)*	93,7	125	156,2	187,5	250
Consumo annuo / Annual Energy Consumption remote version	kWh/a	1156	1183	1673	1752	2321
Potenza frigorifera / Refrigeration power Ø 24 -deft* (Tevap -10°C):	W	620	780	941	1130	1500
Classe climatica / Climate Class	ISO 23953-2	3 - M1				
Superficie espositiva / Display surface	m²	1,70	2,26	2,83	3,39	4,53
Carico uniformemente distribuito piano esposizione Uniformly distributed load dispaly surface:	Kg/m²	105				
Controllo / Control:	ELECTRONIC	WOW Touch Control				

L (cm)*= Lunghezza senza spalle.
Spessore 1 spalla: 4 cm.
L (cm)*= Length without endwalls.
Thickness 1 endwall: 4 cm.



* Le informazioni relative alla classe energetica (secondo le normative Ecodesign 2019/2024 ed Energy Labelling 2019/2018) qui riportate sono riferite a modelli standard e precise configurazioni ed allestimenti del prodotto. La brochure si basa sulle informazioni disponibili al momento della sua pubblicazione. Ogni configurazione diversa da quella ivi rappresentata potrebbe comportare un cambiamento sensibile delle informazioni relative alla classe energetica. Per maggiori informazioni vi invitiamo a consultare il Registro Europeo dei Prodotti per l'Etichettatura Energetica EPREL oppure rivolgerci al nostro servizio crioccare@criocabin.com.

* **EN** The energy class information (according to the Ecodesign 2019/2024 and the Energy Labelling 2019/2018 standards) given here refers to standard models and precise product configurations and fittings. The brochure is based on the information available at the time of its publication. Any configuration other than that depicted therein may result in a significant change in the energy class information. For further information, please consult the European Product Registry for Energy Labelling (EPREL) or contact our service crioccare@criocabin.com.

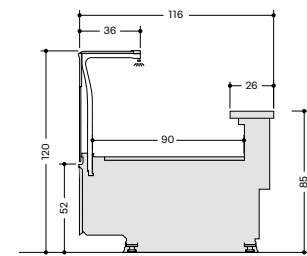

ETOILE

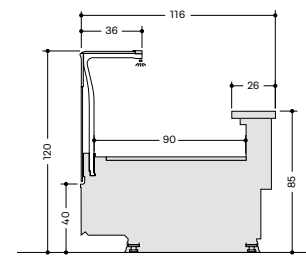

ETOILE LOUNGE

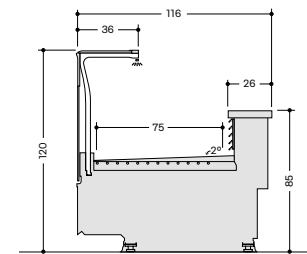

ETOILE S-CONCEPT

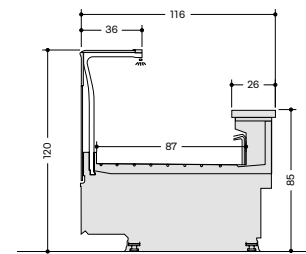

ETOILE G-CONCEPT

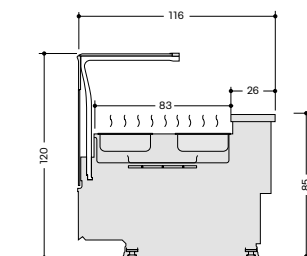

ETOILE H-COMBI

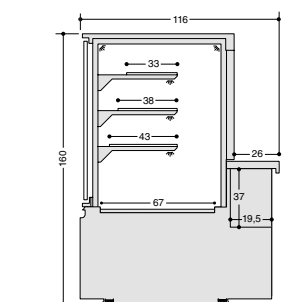

IL MAGNIFICO TOWER

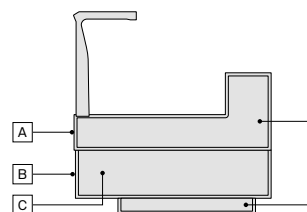

A	A85 RAL* Special Colors* Matt Colors*
B	Standard Colors RAL* Special Colors* Matt Colors* I301* I302* I303*
C	D90 D97 Other Standard Colors* RAL* Special Colors* Matt Colors* I301* I302* I303*
D	I302 I301* I303*

*= Color at Extra cost
*= Colore con sovrapprezzo
*= Supplément couleur
*= Farb mit Aufpreis

Standard Colors			
D90 - White	D91 - Platinum Gray	D97 - Black	D136 - White Oak
D141 - Brushed Anthracite	D142 - Brushed Moka	D143 - Linen	D144 - Smokey Gray
D145 - Grenade	D146 - Blu Sapphire	D147 - Bottle Green	

Special Colors			
P61 - White Perla	P51 - Papaya Orange	P52 - Grano	P53 - Rose Brown
P54 - Must	P84 - Red Tiziano	P55 - Rosa Mountbatten	P56 - Tea Leaf
P57 - Uovo di Pettirosso	P58 - Blu Lavagna	P59 - London Gray	P73 - Black Vulcano

Matt Colors			
M41 - Latte	M42 - Etna	M43 - Bronzo	M44 - Melanzana
M45 - Terra	M46 - Oro		

ETOILE

FUTURISTIC DESIGN TRENDS

CRIOCABIN
TASTE PRESENTATION

CRIOCABIN SpA

35037 Praglia di Teolo - Padova (Italy)
Z.I. Selve - Via S. Benedetto, 40/A

Tel. +39 049 9909100
www.criocabin.com